

REC DISTRIKT

#RENTAL
#STUDIO
#MOTIONCONTROL

CATALOGO 2024

MDP

LIGHT AND GRIP

FLASH

AUDIO

FACILITY

Rental & Studio

Via Adelaide Bono Cairoli, 20
20127 Milano

Booking Rental

rental@recdistrikt.com
342 74 92 831

Booking Studio

studio@recdistrikt.com
342 74 92 831

Orari

dal lunedì al venerdì
09:00 - 13:00
14:00 - 18:30

CONDIZIONI GENERALI DI NOLEGGIO REC DISTRIKT SRL

Il noleggio degli spazi e dei beni materiali di proprietà della nostra società (o di cui Rec Distrikt SRL ha comunque la disponibilità materiale e giuridica), è regolato dalle presenti condizioni generali di noleggio, le quali devono essere integralmente accettate, senza alcuna riserva, al momento della conferma del preventivo mezzo email, ovvero alla firma del preventivo prima della data prevista per il ritiro del materiale, anche ove il ritiro avvenga a mezzo di terzi, o dell'uso degli spazi.

Art. 1

Il materiale e la strumentazione data a noleggio è perfettamente efficiente, collaudata e pronta all'uso cui è destinata e come tale dovrà essere restituita al termine del contratto.

Con la sottoscrizione delle condizioni generali e del DDT, il contraente riconosce espressamente il perfetto stato d'uso, di manutenzione e funzionamento del materiale e della strumentazione e la sua completezza di ogni accessorio necessario al funzionamento.

Il materiale e la strumentazione viene consegnata al contraente presso la sede di Rec Distrikt SRL o nell'indirizzo di consegna stabilito per iscritto.

Qualora il materiale e la strumentazione fosse recuperata da soggetto diverso dal contraente o da un dipendente del contraente stesso, tale circostanza dovrà essere segnalata per iscritto al momento della richiesta di noleggio e il delegato dovrà essere munito di delega scritta, con facoltà di sottoscrizione del DDT di consegna, con assunzione da parte del contraente di ogni responsabilità in merito.

Art. 2

Il materiale dato a noleggio dalla Rec Distrikt SRL è approntato secondo le norme vigenti ed il Cliente che provvederà all'installazione ed allacciamenti, anche a mezzo terzi, dovrà osservare scrupolosamente le norme di sicurezza, assumendosi ogni totale responsabilità di ordine penale, civile e fiscale, manlevando espressamente Rec Distrikt SRL per ogni eventuale danno cagionato a terzi o allo stesso contraente dall'utilizzo del materiale e della strumentazione noleggiata.

Art. 3

Il Cliente è tenuto a comunicare ogni variazione. I noleggi disdetti nelle 24 ore precedenti al giorno del ritiro del materiale, verranno ugualmente fatturati e il contraente sarà tenuto a corrispondere integralmente il prezzo pattuito per il noleggio. Nel caso si trattasse di un ritiro di Lunedì verrà sempre conteggiato il Venerdì come ultimo giorno disponibile per la disdetta.

Art. 4

Il listino può subire variazioni senza preavviso. La Rec Distrikt SRL pratica nelle fatture i prezzi indicati nel suo listino in vigore il giorno del ritiro.

Art. 5

Il materiale noleggiato può essere utilizzato anche all'estero, nel qual caso il conduttore si impegna a chiedere alla Rec Distrikt SRL un'autorizzazione scritta e la preparazione della relativa documentazione.

Art. 6

Il noleggio termina il giorno indicato nella conferma, momento in cui il materiale e la strumentazione dovrà essere riconsegnata in perfetto stato presso la sede della Rec Distrikt SRL.

La riconsegna deve avvenire tassativamente entro le ore 20 dell'ultimo giorno di noleggio o entro le ore 10.00 del giorno successivo all'ultimo giorno di noleggio. Ogni diverso accordo deve risultare per iscritto. A seguito della restituzione, Rec Distrikt SRL provvederà a verificare lo stato del materiale, con facoltà di sollevare osservazioni e contestazioni sino a 5 giorni dalla materiale riconsegna.

In segno di approvazione ai sensi e per gli effetti degli artt. 1341 e ss c.c., il contraente dichiara di accettare espressamente le seguenti clausole (art.1, art. 2, art. 3, art. 4, art. 6, art. 8, art. 9, art. 10 e art. 11), apponendo anche una sigla su ogni pagina, a conferma della presa visione e approvazione specifica di ogni clausola e condizione.

Rec Distrikt SRL Il contraente

In caso di mancata riconsegna nel termine concordato, il contraente sarà tenuto a corrispondere quanto dovuto anche per il giorno previsto per la riconsegna e comunque sino al momento dell'effettiva restituzione, con la conseguenza che ogni eventuale ritardo nella riconsegna del materiale è considerato prolungamento del noleggio stesso, salvo il risarcimento del maggior danno subito.

Art. 7

Il periodo di noleggio, salvo accordi particolari, è dato in giorni, dalla differenza aritmetica risultante dalla data di restituzione e quella del ritiro. Il materiale può essere ritirato il pomeriggio del giorno precedente, dalle ore 16.

Il periodo minimo di noleggio è di 1 giorno.

Art. 8

In caso di materiale mancante, danneggiato, rovinato o utilizzato in modo improprio (comprese a titolo meramente esemplificativo, le lampade bruciate o il costo della lavanderia per i teli), lo stesso verrà addebitato al Cliente al prezzo di mercato.

Non si accettano riconsegne parziali di pezzi di uno stesso apparecchio.

I giorni di noleggio saranno calcolati fino al ritorno integrale e completo di tutto il materiale e della strumentazione noleggiata.

Art. 9

Il contraente prende atto del fatto che il materiale e la strumentazione data a noleggio da Rec Distrikt SRL non è oggetto di assicurazione contro furto e danni, di qualsiasi natura.

Pertanto, il contraente sarà direttamente e integralmente responsabile in caso di furto, incendio, perdita del materiale, essendosi costituito custode dei beni al momento del loro ritiro, anche in caso di ritiro tramite corriere e/o delegato.

In ogni caso, il contraente dovrà informare Rec Distrikt SRL di ogni danno e/o evento che riguarda i beni noleggiati.

Art. 10

Rec Distrikt SRL non potrà essere ritenuta responsabile di alcun danno eventualmente causato al contraente o a terzi, dipendente o comunque connesso all'utilizzo del materiale e della strumentazione noleggiata, ivi incluse ipotesi di danno emergente o lucro cessante per mancato o non corretto funzionamento dei beni, il cui stato era comunque conforme al momento della consegna.

Ogni eventuale contestazione sullo stato dei beni dovrà essere sollevato, a pena di decadenza, al momento del ritiro.

Art. 11

Ogni eventuale controversia relativa all'interpretazione e/o all'esecuzione del presente contratto sarà devoluta alla competenza esclusiva del foro di Milano, escluso ogni altro foro.

INDICE



Dolly



Sistemi di ripresa



Teleprompter



Gimbal



Crane e Jib



Slider



Pedane



Camera car



Led



Modificatori



Dimmer e DMX



Fluorescenza



HMI



Tungsteno



CRLS



Teli e telai



Stativi



Fog machine



Generatori



Prolunghe e adattatori

DOLLY



CineTech Hawk I

449 €

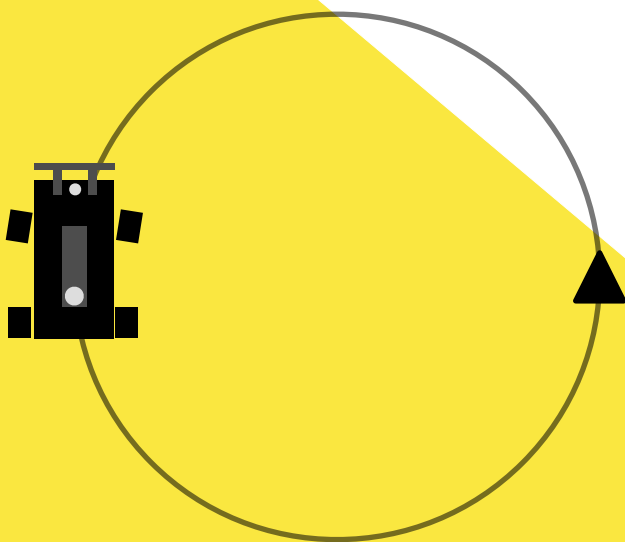

Conventional

Le ruote posteriori girano di 360° e le ruote davanti restano ferme

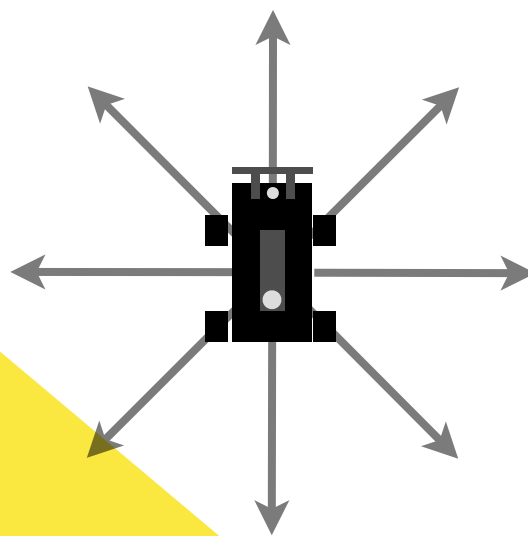

Crab

Le ruote posteriori e anteriori girano di 360° all'unisono

Peso	210 kg
Lunghezza	108 cm
Larghezza minima	69 cm
Larghezza massima	100 cm
Altezza minima (low mode)	1 cm
Altezza massima	131 cm
Escursione braccio	83 cm
Alimentazione	No
Carico massimo	50 kg
Pressione base	80 bar
Pressione massima	250 bar
Numero salite per carica	5

Accessori Hawk I

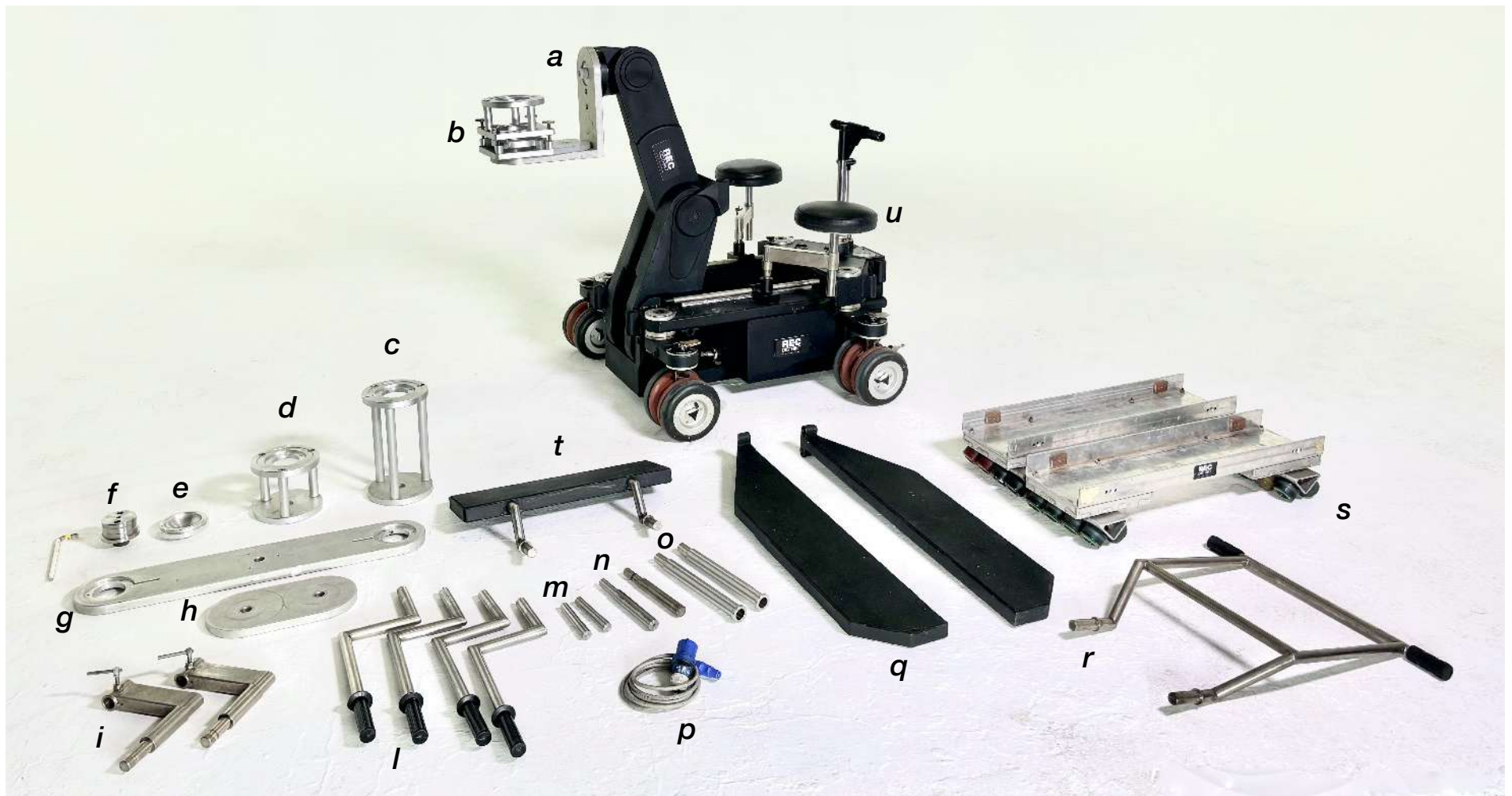

Sul retro si trova la la leva per caricare **manualmente** la pressione del pistone idraulico.



Da usare abbinato a un Instagrid

<i>a_Piastra a L con dado e bullone per low mode</i>	<i>x 1</i>
<i>b_Piastra Mitchell con piano regolabile</i>	<i>x 1</i>
<i>c_Prolunga Mitchell</i>	<i>x 1</i>
<i>d_Prolunga Mitchell</i>	<i>x 1</i>
<i>e_Riduzione coppa 100mm</i>	<i>x 1</i>
<i>f_Cinquino bazooka</i>	<i>x 1</i>
<i>g_Piastra per doppia camera Mitchell mount</i>	<i>x 1</i>
<i>h_Estensione piastra</i>	<i>x 1</i>
<i>i_L per sellino</i>	<i>x 4</i>
<i>l_Maniglie</i>	<i>x 4</i>
<i>m_Perni corti per pedane laterali</i>	<i>x 2</i>
<i>n_Perni lunghi per pedane laterali</i>	<i>x 2</i>
<i>o_Prolunga seggiolino / Leva per ricarica pressione</i>	<i>x 2</i>
<i>p_Cavo alimentazione powercon / Scame</i>	<i>x 1</i>
<i>q_Pedane laterali</i>	<i>x 2</i>
<i>r_Manubrio per spinta</i>	<i>x 1</i>
<i>s_Rec Distrikt Boogie wheels</i>	<i>x 2</i>
<i>t_Pedana frontale</i>	<i>x 1</i>
<i>u_Sellino</i>	<i>x 2</i>



GFM GF-Quad Dolly

(su ruote)

179 €



Seat

Seat arm

Euro riser set
(Serie bazooka)

Coppa 150mm

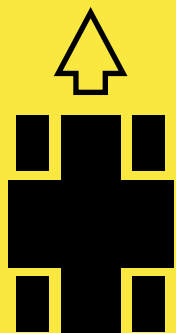

**Ruote anteriori dritte
Ruote posteriori dritte**

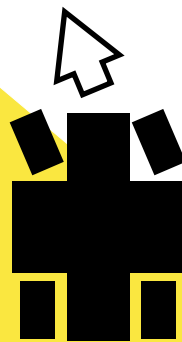

**Ruote anteriori curve
Ruote posteriori dritte**

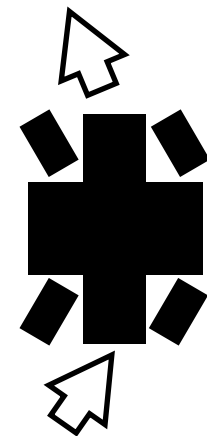

**Ruote anteriori curve
Ruote posteriori curve**



GFM GF-Quad Dolly

(su binario)

199 €



Procedura per sostituire le ruote con le Track Wheels



Sollevarre il dolly con le 4 levelling legs



Estrarre i pneumatici



Inserire le Track wheels

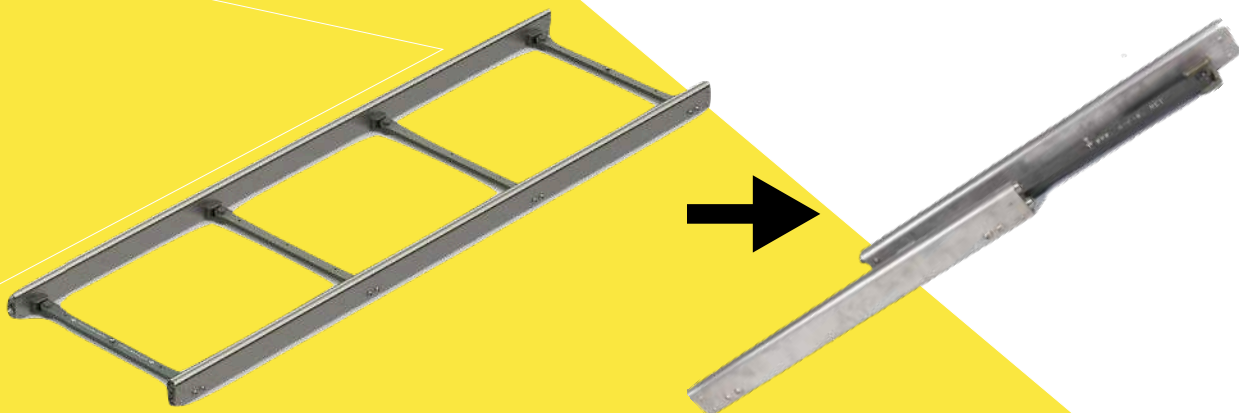

Binario pieghevole 1,6m
15 € cad.

Lunghezza da aperto 200 cm
Lunghezza da chiuso 160 cm



Sistema di serraggio cardini

Si consiglia l'utilizzo di zeppe, tacchette, tiranti, mezzi morali e cantinelle per mettere in bolla il binario su superfici sconnesse.



RecDistrikt | Snorricam

159 €

<i>a_Piastra frontale con prolunga per testa video</i>	<i>x 1</i>
<i>b_Corpetto Tilta</i>	<i>x 1</i>
<i>c_Contrappesi</i>	<i>x 5</i>
<i>d_Piastra posteriore con cuscinetto nero per schiena</i>	<i>x 1</i>
<i>e_Mezzi fustoni 50 cm</i>	<i>x 4</i>
<i>f_Cipolle</i>	<i>x 4</i>
<i>g_cardellino</i>	<i>x 1</i>
<i>h_testa video</i>	<i>x 1</i>
<i>i_Prolunga per testa video</i>	<i>x 2</i>



Questo modello di Snorricam, liberamente ispirato all'originale Brand americano, permette di avere una ripresa in POV estremamente stabile senza l'ausilio di bretelle o cinghie di supporto per il corpetto..

*Può portare MDP fino a **7kg**. Compatibile con operatori alti fino a 180cm. Sconsigliata la corsa. Per un utilizzo prolungato è consigliabile avere un fisico allenato.*

SISTEMI DI RIPRESA



TILTA Hydra Alien
Car mounting system

79 €



TILTA Hermit POV
Support System Large

99 €



Proaim Cinebird
Camera Rickshaw Dolly

199 €



Gancio
con snodo e prolunga

9 €

Doniselli
Bicicletta

39 €

GIMBAL



**DJI Ronin 2
Pro Combo**

349 €



**DJI Ring
Grip Plus - Base**

69 €



**DJI Ronin S 3
Pro Combo**

149 €



**DJI Ronin S 2
Pro Combo**

129 €



DJI Ronin S

99 €

TELEPROMPTER



KIT TELEPROMPTER 19"

Teleprompter Mac Book Treppiede

199 €

99 €

59 €



TELEPROMPTER 10"

Adatto per mirrorless

99 €



EYE DIRECT

159 €

TALENT

Specchio

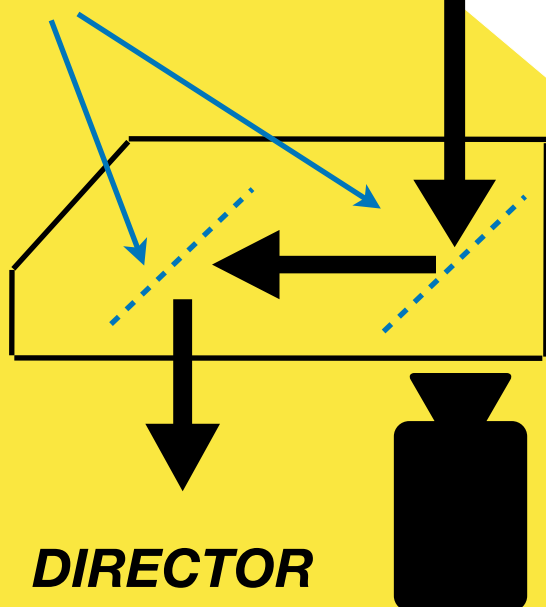

DIRECTOR

*L'Eye Direct serve per aiutare i talent a guardare in camera e **tenere il contatto visivo** con il Regista.*

Il Regista starà accanto alla camera e il talent non vedrà il "buco nero" dell'obbiettivo, che per chi è alle prime armi può essere un grande ostacolo emozionale, ma vedrà il volto del Regista che lo sta intervistando.

CRANE



MAX REACH	4,9m
MIN REACH	0,8m
MAX PAYLOAD	36kg
WEIGHT FULL EXTENSION	68kg
CONTROBILANCIAMENTO	40-100 kg

Come testa motorizzata è possibile utilizzare il Ronin 2 Pro Combo, utilizzando il Ronin 2 - Mitchell mount



MOVIEGRIP DESIGN | Modular Crane

499 €



MAX REACH	2m
MIN REACH	1m
MAX PAYLOAD	9kg
WEIGHT FULL EXTENSION	17kg
CONTROBILANCIAMENTO	20-60 kg

Non utilizzabile con Ronin 2 Pro, si consiglia di usare un Ronin S2 o Ronin S3.



KESSLER CRANE | KC-12

139 €

JIB



GFM | GF - Tele Jib

229 €



REACH RETRACTED	103 cm
REACH EXTENDED	156 cm
MAX PAYLOAD RETRACTED	45 kg
MAX PAYLOAD EXTENDED	30 kg
REAR RETRACTED	37 cm
REAR EXTENDED	54 cm
LIFT RANGE RETRACTED	143 cm
LIFT RANGE EXTENDED	230 cm
MAX COUNTERWEIGHT	96 kg
TILT ANGLE	56°
JIB WEIGHT	25 kg

GF- Tele Jib	x 1
Cucchiaia 30cm bowl 150mm	x 1
Cinquino doppio bazooka M-M	x 1
Tube low mode 40cm	x 1
Contrappesi	x 8

SLIDER

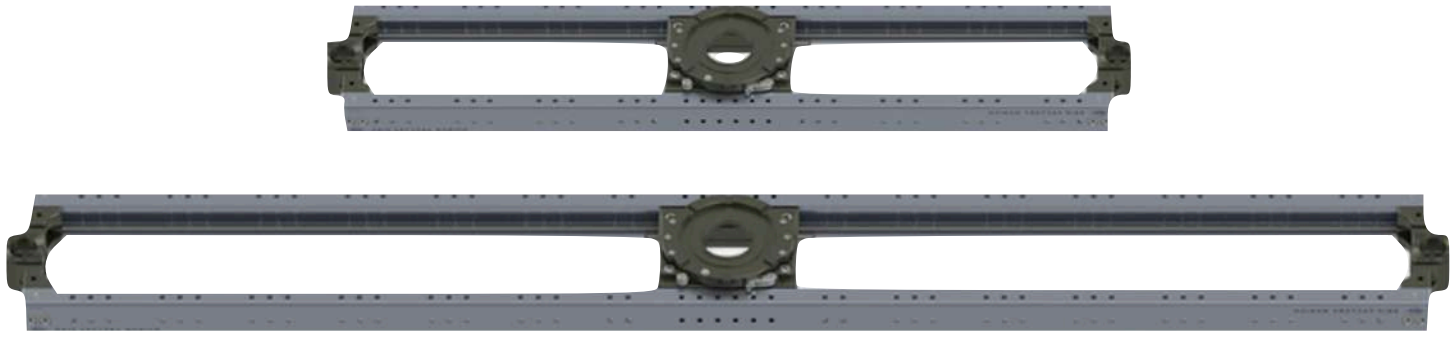

GFM | GF - Slider

179 € / 120 cm
219 € / 200 cm

Mount



100 mm



150 mm



Mitchell



M Bazooka

LUNGHEZZA	120 cm / 200 cm
CARRELLO	flat / 8 cm
MOUNT	Mitchell / Bowl / Euro
BASE	Euro mount
PAYLOAD	40 Kg



Carrello con rialzo di 3 cm



Carrello con rialzo di 8 cm



Base F Bazooka con Pan

99 €

Questa versione è indispensabile quando si utilizza la base F Bazooka per il GF-Slider perché permette al sarchiapone di non sbattere sulla vite blocca Bazooka



LUNGHEZZA 90 cm / 160 cm

CARRELLO flat

MOUNT Bowl 100 mm / 150 mm

BASE ---

PAYLOAD 20 Kg

MOVIE TECH | Scooter Dolly

179 €



*(Serve una testa video per rendere lo slider operativo)

CARRELLO flat

MOUNT 3/8"

BASE 3/8"

PAYLOAD 5 Kg

LUNGHEZZA 90 cm

KESSLER | Cineslider

69 €

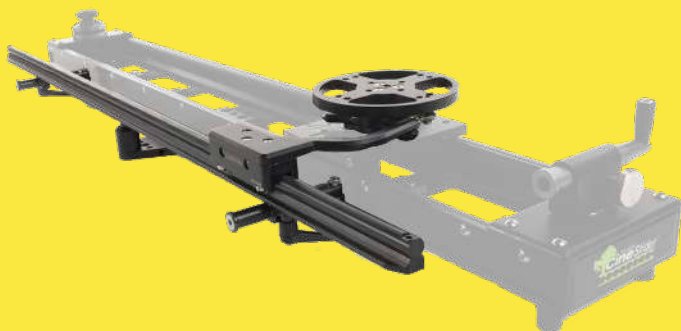

KESSLER | Parallax

179 €



KESSLER | Second Shooter

59 €

PEDANE GIREVOLI



videoclip by Borotalco.tv - Marcella Bella "Tacchi a Spillo"

	Altezza	Payload	
Pedana Ø 120 cm	9 cm	600 kg	249 €
+ Base Ø 160 cm	12 cm	---	49 €
Tinteggiatura			49 €

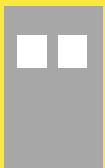

Comando a distanza

La nostra pedana da 120cm di diametro abbina una incredibile portata, tiene fino a 600kg e ha un'altezza dal suolo minima di soli 9cm.

È di **facilissima installazione** e si comanda a distanza con un telecomando simile a quello dei cancelli automatici.

In caso serva un diametro maggiore, ad esempio per far girare **una moto**, abbiamo una pedana da 160cm di diametro che può essere installata sopra la base da 120cm.

PEDANE GIREVOLI



	<i>Altezza</i>	<i>Payload</i>	
<i>Pedana Ø 60 cm</i>	9 cm	150 kg	99 €
<i>Pedana Ø 40 cm</i>	9 cm	4 kg	29 €
<i>Pedana Ø 30 cm / Ø 50 cm</i>	9 cm	90 kg	49 €



MOVIEGRIP | Crazy Round

179 €

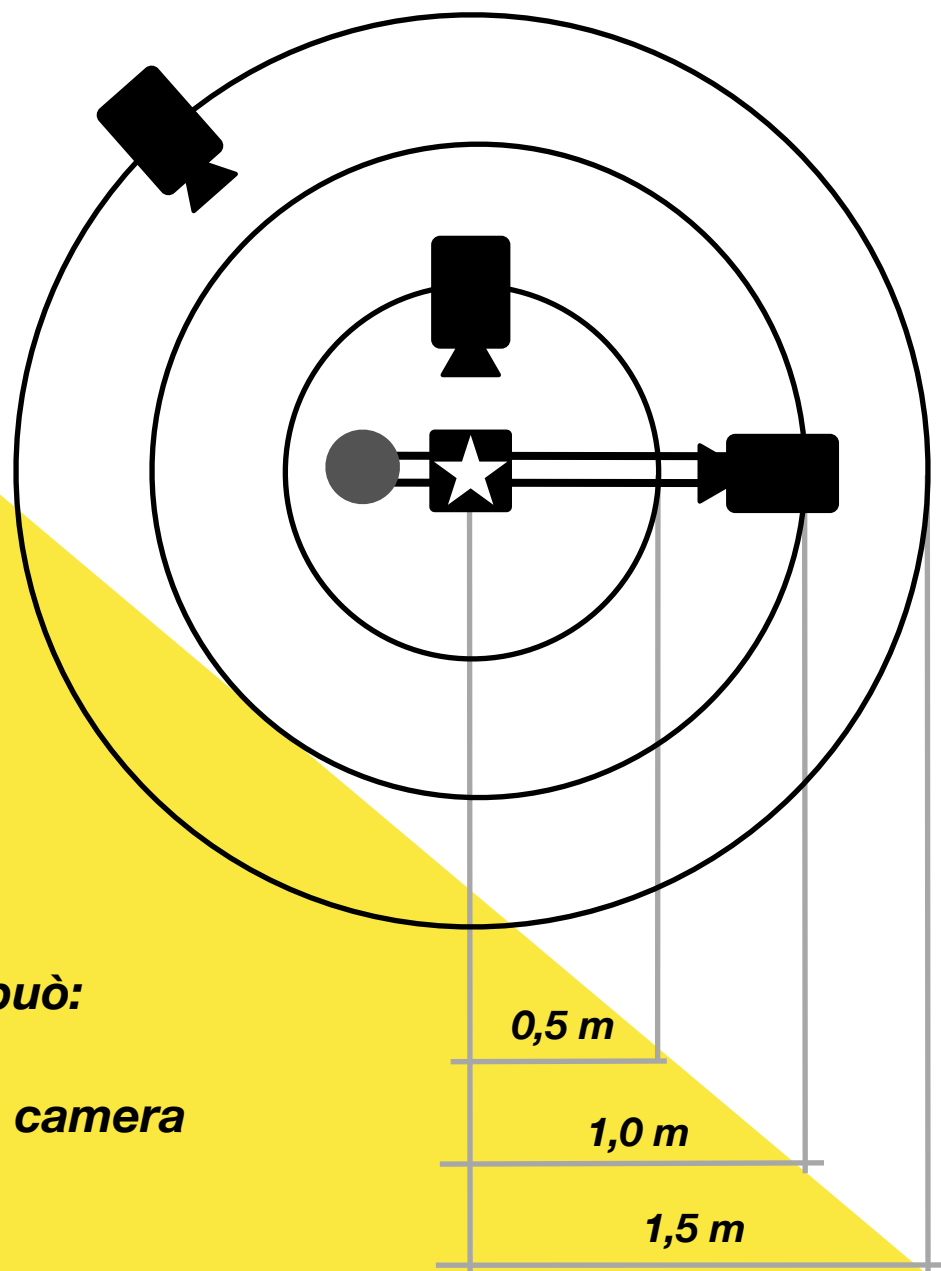

Il soggetto al centro può:
A _restare fermo
B_ girare insieme alla camera

CAMERA CAR



Manfrotto Kit camera car

99 €



E-Image A-40

99 €



Kupo A-40

39 €



Ventosa con maniglia

29 €



Manfrotto 241

9 €



9.Solution Ventosa

9 €



Magic arm

9 €



Doppio aliscafo

9 €



Codolo

1 €



Spigot

1 €



Cardellino

9 €



Fustone

3 €



Cipolla

2 €



Cinghia

2 €



Tubi in alluminio 30 cm, 50 cm, 1m, 1,5m, 2m

9 €



MOVIEGRIP | Sediola

99 €



MOVIEGRIP | Violino

99 €



ATTENZIONE: Per utilizzare questi due kit è indispensabile l'intervento di un **macchinista** e sono da corredare con cinghie, panni, ventose, cardellini, mezzi fustoni e altri accessori da Camera Car.

GRIP SUPPORT



Stella Bazooka

19 €



Serie Bazooka

29 €



Coppa Bowl 100 / 150 mm

19 €



Cartoni Ragno

39 €



Cucchiaica 30cm / Bowl 150 mm

19 €



Cucchiaica 1 m Mitchell / Bowl 150 mm

39 €

GRIP SUPPORT



Quaker Clamp

6 €



Polyholder

6 €



Forca

3 €



Walter

3 €



Corda

2 €



Clamp

2 €



Cardellino corto

9 €



Cardellino medio

9 €



Cardellino lungo

9 €



Stecca molloni

3 €



Pinzone 1000

2 €



Pinzone 2000

6 €



Spigot

1 €



Codolo

1 €



Perno 28M-16F

2 €



Perno 28M-16M

2 €



Perno 16M-28F

2 €



Gancio a C

9 €



KCP-835D

9 €

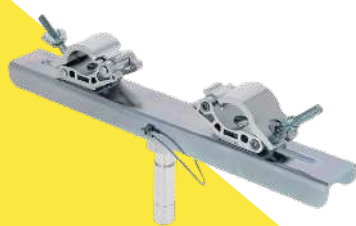

Supporto americane

19 €



Pipa a sbalzo

9 €



Lollypop

9 €



Cipolla

3 €



Cipolla Skyrapid

9 €

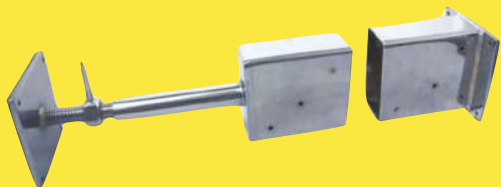

KCP-724 5x10 cm

39 €



Doppio aliscaf

9 €



Aliscaf Perno M

9 €



Aliscaf Perno F

9 €



Barilotto

9 €



ARRI | Skypanel S120 | S60 | S30

	<i>Skypanel S120</i>	<i>Skypanel S60</i>	<i>Skypanel S30</i>
POTENZA	430 W	450 W	220 W
PESO	16 kg	11,7 kg	8 kg
LARGHEZZA	133 cm	82 cm	39 cm
ALTEZZA	58 cm	56 cm	49 cm
PROFONDITÀ	13 cm	13 cm	13 cm
CRI	95 >	95 >	95 >
BILANCIAMENTO BIANCO	2,8 k - 10k	2,8 k - 10k	2,8 k - 10k
COLORE	Si	Si	Si
MOUNT	Perno 28 M	Perno 28 M	Perno 28 M
CLASSE DI PROTEZIONE	IP20	IP20	IP20
	209 €	159 €	99 €

ARRI | Accessori Skypanel



ARRI V-Mount battery plate
per Skypanel S30

29 €



ARRI Skypanel Remote

29 €



ARRI Center Yole mount

9 €

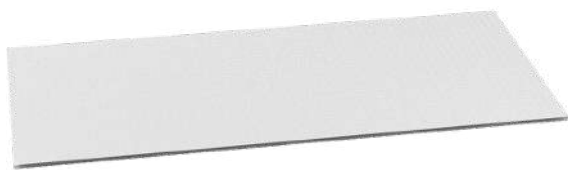

ARRI Intensifier panel
per Skypanel S60

19 €



ARRI S 60 Honey comb 60°
per Skypanel S60

29 €



ARRI S 60 Barn doors
per Skypanel S60

29 €



Chimera Octa Plus 5
per Skypanel S60 + Grid 50°

179 €

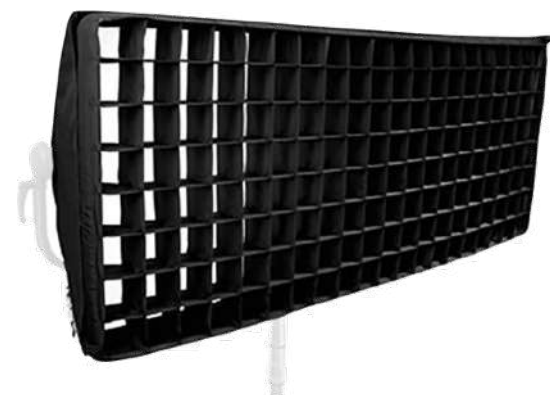

DoP Choice Snap Grid
per Skypanel S120/S60/S30

39€ / 29€ / 19€



DoP Choice Snap Bag
per Skypanel S120/S60/S30

39€ / 29€ / 19€

RGBW LED TUBE



ASTERA | TITAN

189 €

LUNGHEZZA	120 cm
PESO	1,3 kg
AUTONOMIA	+ 20 ore
POTENZA	72 w



ASTERA | HELIOS

159 €

LUNGHEZZA	60 cm
PESO	0,7 kg
AUTONOMIA	+ 20 ore
POTENZA	28 w

SMALL EMITTERS



APUTURE MC-2
49 €

NANLITE Pavotube ii C
69 €

ROSCO DMG DASH
149 € (Full Kit) 39 € (Single)



APUTURE B7C BULB
89 €

ASTERA NYX BULB
89 €



RD RING
69 €

OTHER EMITTERS



POTENZA	100 W
PESO	0,38 Kg
LARGHEZZA	30 cm
ALTEZZA	15 cm
PROFONDITÀ	10 cm
CRI	95 >
BILANCIAMENTO BIANCO	2.7k - 7.5k
COLORE	Nope
MOUNT	Foro 1/4 "
CLASSE DI PROTEZIONE	IP 2
DURATA A BATTERIA	15'

ZHIYUN X100 Combo Molus

49 €



POTENZA	720 W
PESO	24 Kg
LARGHEZZA	94 cm
ALTEZZA	91 cm
PROFONDITÀ	21 cm
CRI	95 >
BILANCIAMENTO BIANCO	2.8k - 5.6k
COLORE	Nope
MOUNT	Perno 28 M
CLASSE DI PROTEZIONE	IP 20

LIGHTSTAR LUXED 4

129 €

OTHER EMITTERS



DEDOLIGHT | DLED7

Caratteristiche

179 €

In the box

POTENZA	90 W
APERTURA	8 to 60° Spot-to-Flood
LARGHEZZA	48 cm
ALTEZZA	29 cm
PROFONDITÀ	2 cm
CRI	97 >
BILANCIAMENTO BIANCO	2.7 K -6.5 K
COLORE	No
MOUNT	Perno 16 mm

x2 Luci
 x2 Alimentazioni cavi alimentazione 15A
 x2 Alimentatori D-Tap Femmina
 x2 Plate V-Mount
 x2 Power Supply
 x2 DP2.2 Shutter Projector
 x2 DP1.2 Imaging Projector
 x5 Gobi
 x2 Barn Doors
 x2 Light Shield Ring
 x2 Spigot



POTENZA	200 W
PESO	2,9 kg
LARGHEZZA	101 cm
ALTEZZA	53 cm
PROFONDITÀ	2 cm
CRI	95 >
BILANCIAMENTO BIANCO	2 K - 11 K
COLORE	Full RGB+W color gamut
MOUNT	Perno 16 mm

LITEGEAR LiteMat Spectrum 4

349 €



POTENZA	200 W
PESO	2,9 kg
LARGHEZZA	101 cm
ALTEZZA	53 cm
PROFONDITÀ	2 cm
CRI	95 >
BILANCIAMENTO BIANCO	2 K - 11 K
COLORE	No
MOUNT	Perno 16 mm

LITEGEAR LiteMat+4

299 €



POTENZA	100 W
PESO	1,7 kg
LARGHEZZA	48 cm
ALTEZZA	29 cm
PROFONDITÀ	2 cm
CRI	95 >
BILANCIAMENTO BIANCO	2 K - 11 K
COLORE	Full RGB+W color gamut
MOUNT	Perno 16 mm

LITEGEAR LiteMat Spectrum 2 L

249 €



POTENZA	240 W
PESO	0,8 kg
LARGHEZZA	60 cm
ALTEZZA	60 cm
PROFONDITÀ	1 cm
CRI	95 >
BILANCIAMENTO BIANCO	2.5 K - 7.5 K
COLORE	Full RGB+W color gamut
MOUNT	Perno 16 mm

APUTURE Flexible F22 C

89 €

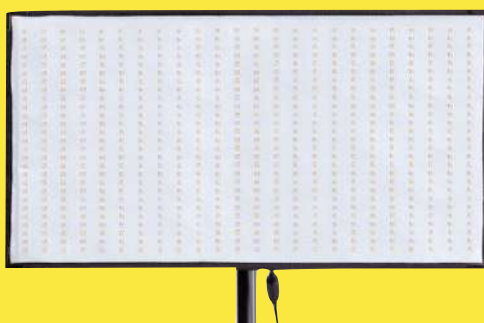

POTENZA	40 W
PESO	0,4 kg
LARGHEZZA	60 cm
ALTEZZA	30 cm
PROFONDITÀ	1 cm
CRI	98 >
BILANCIAMENTO BIANCO	2.2 K - 12 K
COLORE	Full RGB+W color gamut
MOUNT	Perno 16 mm

ALADDIN ALL IN TWO

79 €

APUTURE COB



APUTURE | 1200D - 600C - 600X - 300C - 60X

	1200D	600C	600X	300C	300X	60X
POTENZA	1440 W	720 W	720 W	360 W	350 W	90 W
PESO LUCE	9 kg	5,8 kg	4,6 kg	2,6 kg	3,1 kg	1,8 kg
PESO BALLAST	5,8 kg	5,2 kg	4,8 kg	No ballast	2,3 kg	0,3 kg
WATER RESISTANT	Si	Si	Si	No	Si	No
V-LOCK MOUNT	No	Si	Si	No	Si	Si
CRI	96 >	96 >	95 >	95 >	96 >	96 >
WHITE BALANCE	5.6 K	2,3k-10k	2,7k-6,5k	2,5 k - 7,5k	2,7k-6,5k	2,7k-6,5k
COLORE	No	Si	No	Si	No	No
MOUNT	Perno 28	Perno 28	Perno 28	Perno 28	Perno 28	Perno 28
IP PROTECTION	IP20	IP20	IP20	IP20	IP20	IP20
	179 €	99 €	79 €	59 €	59 €	39 €

MODIFICATORI DI LUCE



APUTURE
Spotlight 19° / 26° / 36°
59 €



APUTURE
F10 / X2
29 €



APUTURE
Barndoors F10
19 €



APUTURE
Hyper Reflectors
19 €



JINBEI
Octa 150
39 €



JINBEI
Octa 120
29 €



JINBEI
Octa 120 - Deep
29 €



JINBEI
Strip 140x35
29 €



APUTURE
Lantern 90 / 120
39 € / 59 €



APUTURE
Light Dome 150
49 €



APUTURE
Light Dome 120
39 €



APUTURE
Light Dome II / III
39 €



APUTURE
Light Dome 30x120
39 €



APUTURE
Light Dome Mini III
29 €

DMX e DIMMER



DISTANZA DI TRASMISSIONE	500-1000 m
PESO	185 g
PROTOCOLLO DMX	DMX512-A
FREQUENZA DMX	0,8 – 830 Hz
ANTENNA	Omnidirezionale, 2.4GHZ 2.0dBi, RP-SMA
COMPATIBILITÀ	Dispositivi DMX

EXALUX Connect TX / RX

39 € / TX 39 € / RX Cad.



CONTROL FADER	20
5 PIN DMX PORT	1
USB PORT	1
PLAYBACK PAGES	10 (200 TOTALI)
DISPLAY MULTI-TOUCH	7"
RDM DISCOVERY	YES

COLOURSOURCE ETC 20Ch

89 €

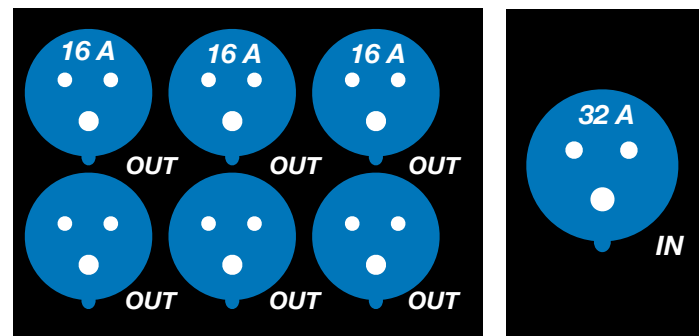

INPUT	1 x 32 P
OUTPUT	6 X 16 A
5 PIN DMX PORT	1

ADB 6 X 3 Kw

69 €

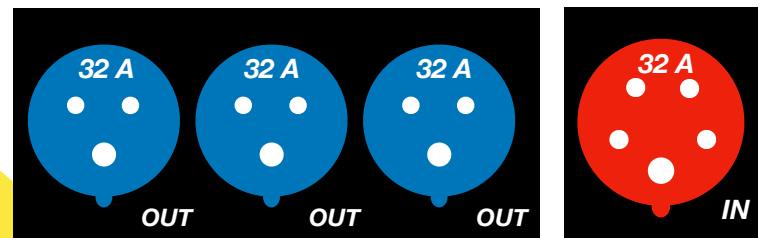

INPUT	1 x 32 P
OUTPUT	3 X 32 A
5 PIN DMX PORT	1

ADB 3 X 5 Kw

69 €

FLUORESCENZA



KINOFLO | Select FE

2 X 60	75 Wh	3200-5600 K	39€
4 X 60	150 Wh	3200-5600 K	49€
2 X 120	150 Wh	3200-5600 K	49€
4 X 120	300 Wh	3200-5600 K	69€
10 X 120	750 Wh	3200-5600 K	99€

Scocca 4 x 120 19 €

HMI



POTENZA	1800 W
PESO	14 Kg
LARGHEZZA	38 cm
ALTEZZA	65 cm
PROFONDITÀ	39 cm
CRI	95 >
BILANCIAMENTO BIANCO	6k
COLORE	Nope
BEAM ANGLE	Da 20° a 60°
CLASSE DI PROTEZIONE	IP 23



220 V
16A

ARRI | M18

109 €



POTENZA	4000 W
PESO	22 Kg
LARGHEZZA	53 cm
ALTEZZA	83 cm
PROFONDITÀ	52 cm
CRI	95 >
BILANCIAMENTO BIANCO	6k
COLORE	Nope
BEAM ANGLE	Da 18° a 52°
CLASSE DI PROTEZIONE	IP 23







220 V
32A

ARRI | M40

199 €

TUNGSTENO



ARRI	T5	Fresnel	5000 w	15 Kg	 220 V 32A	39 €
ARRI	T2	Fresnel	2000 w	8 Kg	 220 V 16A	29 €
ARRI	T1	Fresnel	1000 w	7 Kg	 220 V 16A	29 €
ARRI	650	Fresnel	650 w	3 Kg	 220 V 16A	19 €
ARRI	300	Fresnel	300 w	2 Kg	 220 V 10A	9 €
ARRI	150	Fresnel	150 w	1 Kg	 220 V 10A	9 €



Aircraft 8 x 600 W

89 €

POTENZA	4800 W
PESO	2,9 kg
LARGHEZZA	101 cm
ALTEZZA	53 cm
PROFONDITÀ	2 cm
CRI	95 >
BILANCIAMENTO BIANCO	2 K - 11 K
COLORE	Full RGB+W color gamut
MOUNT	Perno 16 mm

220 V
32A



SPOTLIGHT MILANO *Figura 25*

59 €

POTENZA	2500 W
PESO	2,9 kg
LARGHEZZA	101 cm
ALTEZZA	53 cm
PROFONDITÀ	2 cm
CRI	95 >
BILANCIAMENTO BIANCO	2 K - 11 K
COLORE	No
MOUNT	Perno 16 mm

220 V
16A



ETC *Sagomatore 750w 19°*

39 €

POTENZA	100 W
PESO	1,7 kg
LARGHEZZA	48 cm
ALTEZZA	29 cm
PROFONDITÀ	2 cm
CRI	95 >
BILANCIAMENTO BIANCO	2 K - 11 K
COLORE	Full RGB+W color gamut
MOUNT	Perno 16 mm

220 V
16A



ETC *S4 Junior Zoom 575w 25-50°*

39 €

POTENZA	240 W
PESO	0,8 kg
LARGHEZZA	60 cm
ALTEZZA	60 cm
PROFONDITÀ	1 cm
CRI	95 >
BILANCIAMENTO BIANCO	2.5 K - 7.5 K
COLORE	Full RGB+W color gamut
MOUNT	Perno 16 mm

220 V
16A



PAR 1000w Spot / Flood

19 €

POTENZA	1000 W
PESO	0,4 kg
LARGHEZZA	30 cm
ALTEZZA	30 cm
PROFONDITÀ	60 cm
CRI	98 >
BILANCIAMENTO BIANCO	2.2 K - 12 K
COLORE	Full RGB+W color gamut
MOUNT	Perno 16 mm

220 V
16A

TUNGSTENO



TECNOFLY 2008 | Lighting Luna 250

199 €

Lampada	Tungsteno
Consumo	2000 W
Temperatura colore	3200° K
Diametro	2,5 m
Volume	8 m cubi
Max altezza operativa	10m
Costo Elio	900€ circa

CRLS



CRLS | DIFF. 1 - 2

99 €

CRLS | DIFF. 1 - 3

99 €



CRLS | C-Drive

119 €

x 4 Diffusion 1 50cm / 25cm / 15cm / 7cm

x 4 Diffusion 2 50cm / 25cm / 15cm / 7cm

x 4 Diffusion 3 50cm / 25cm / 15cm / 7cm

x 4 Diffusion 4 50cm / 25cm / 15cm / 7cm

CRLS

Cine Reflect Lighting System

Il sistema CRLS permette di modellare un fascio di luce a 5 livelli intermedi.



Diffusion 0

La diffusione zero riflette la luce al pari di uno specchio. A differenza di uno specchio però non è fatto di vetro e risulta un oggetto meno pericoloso.



Diffusion 1

La diffusione uno riflette la luce senza perdite, ma il fascio è leggermente più aperto e non trasmette eventuali imperfezioni della superficie.



Diffusion 2

La diffusione due "apre" la luce con più consistenza ma si mantiene un buon livello di direzionalità.



Diffusion 3

La diffusione tre "apre" la luce in modo più significativo trasmettendo un fascio morbido e diffuso..



Diffusion 4

La diffusone quattro lavora come un polistirolo, con la differenza che la sua superficie è più rigida e più facile da gestire.



Dimensioni

Ci sono 5 dimensioni possibili:

CRLS 100: 1m x1m double face

CRLS 50: 50x50 cm

CRLS 25: 25x25 cm

CRLS 15: 15x15 cm

CRLS 7: 7x7 cm

CRLS

Cine Reflect Lighting System

Il sistema CRLS è nato per ridurre i volumi di ferro/grip in lista e i relativi tempi di carico e scarico. Il tempo guadagnato deve essere investito in creatività per la creazione della luce.

Le possibilità creative che offrono i CRLS sono infinite e dopo il primo utilizzo ci si rende conto di quanto sia facile da utilizzare e di come può cambiare il proprio approccio nei confronti della Fotografia.

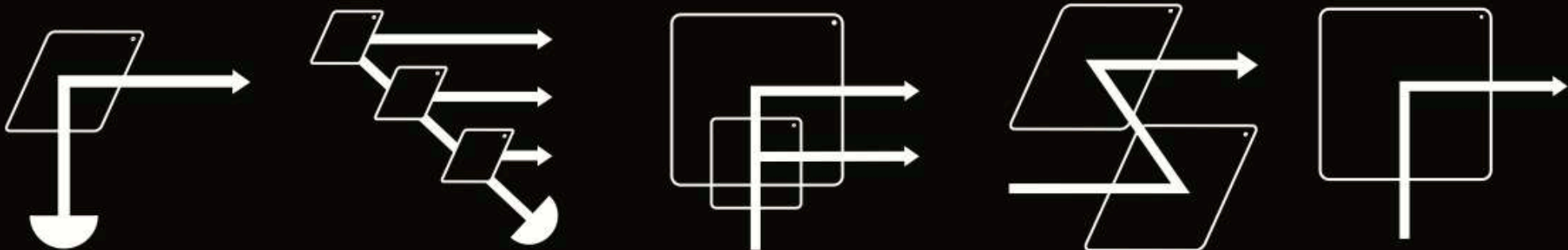

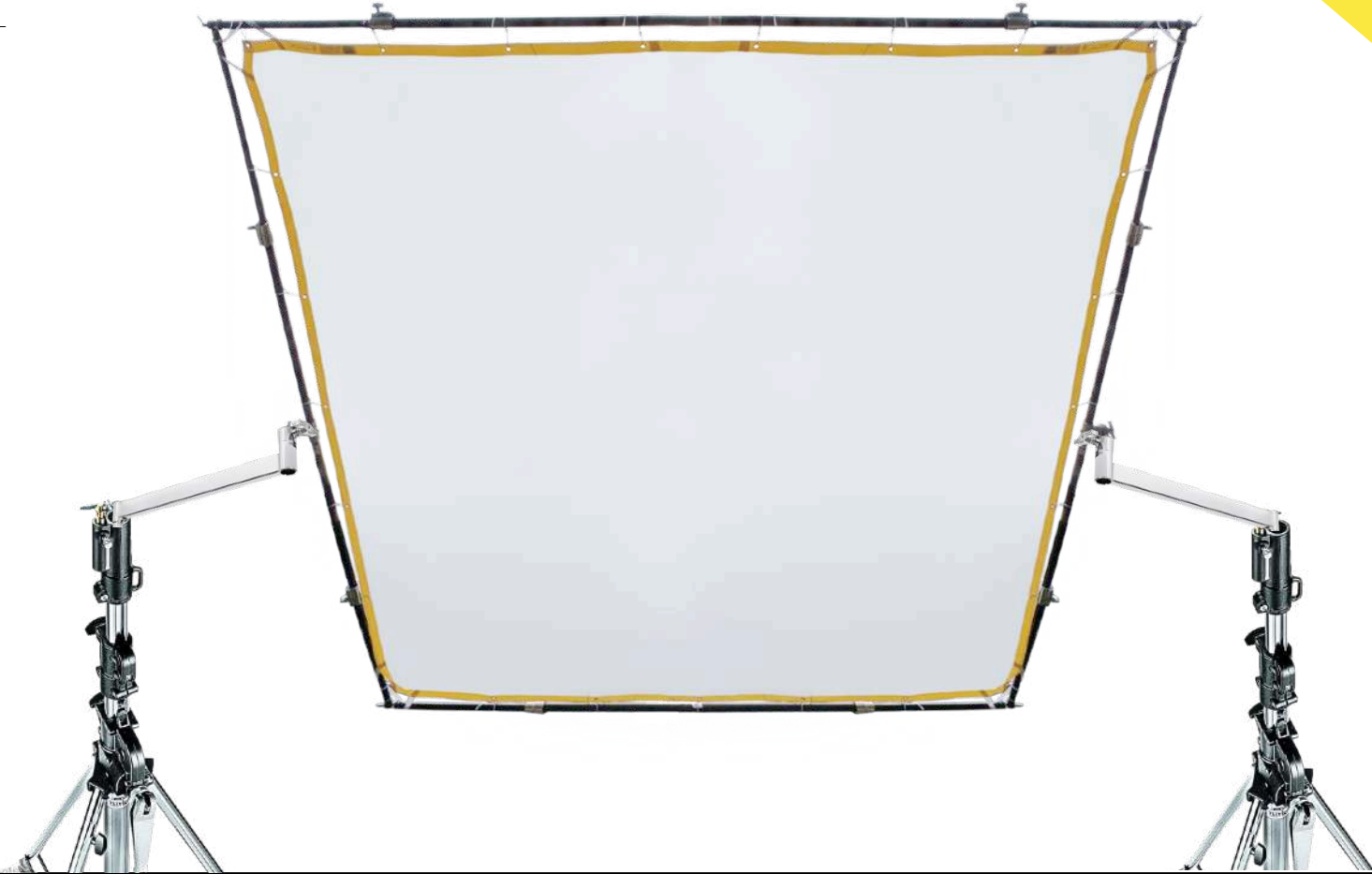

FARFALLA | 2X2 | 4X4 | 6X6

Telaio 2X2

29 €

Telaio 4X4

39 €

Telaio 6X6

89 €

Teli 2X2

BLACK SOLID

ULTRA BOUNCE

GRID CLOTH Full - 1/2 - 1/4

BEMBERG

SILK 1/2 - 1/4

UNBLEACHED

CHECKERBOARD S/G

Teli 4X4

BLACK SOLID

ULTRA BOUNCE

GRID CLOTH Full - 1/2 - 1/4

BEMBERG

SILK 1/2 - 1/4

UNBLEACHED

CHECKERBOARD S/G

GREEN

WHITE SOLID

Teli 6X6

BLACK SOLID

ULTRA BOUNCE

GRID CLOTH 1/2

BEMBERG

19 € Cad

29 € Cad.

79 € Cad



Le misure di teli e telai **sono approssimazioni**, in realtà:

2x2 è 1,8 x 1,8 m

4x4 è 3,6 x 3,6 m

6x6 è 5,4 x 5,4 m



T-BONE | 4X4 | 6X6

T-BONE 4X4

19 €

T-BONE 6X6

29 €



Il T-Bone, o maschio farfalla, o in gerco "cristo" viene utilizzato per capannare o per isolare e dividere spazi. Si consiglia l'utilizzo di un Windup per alzarlo.

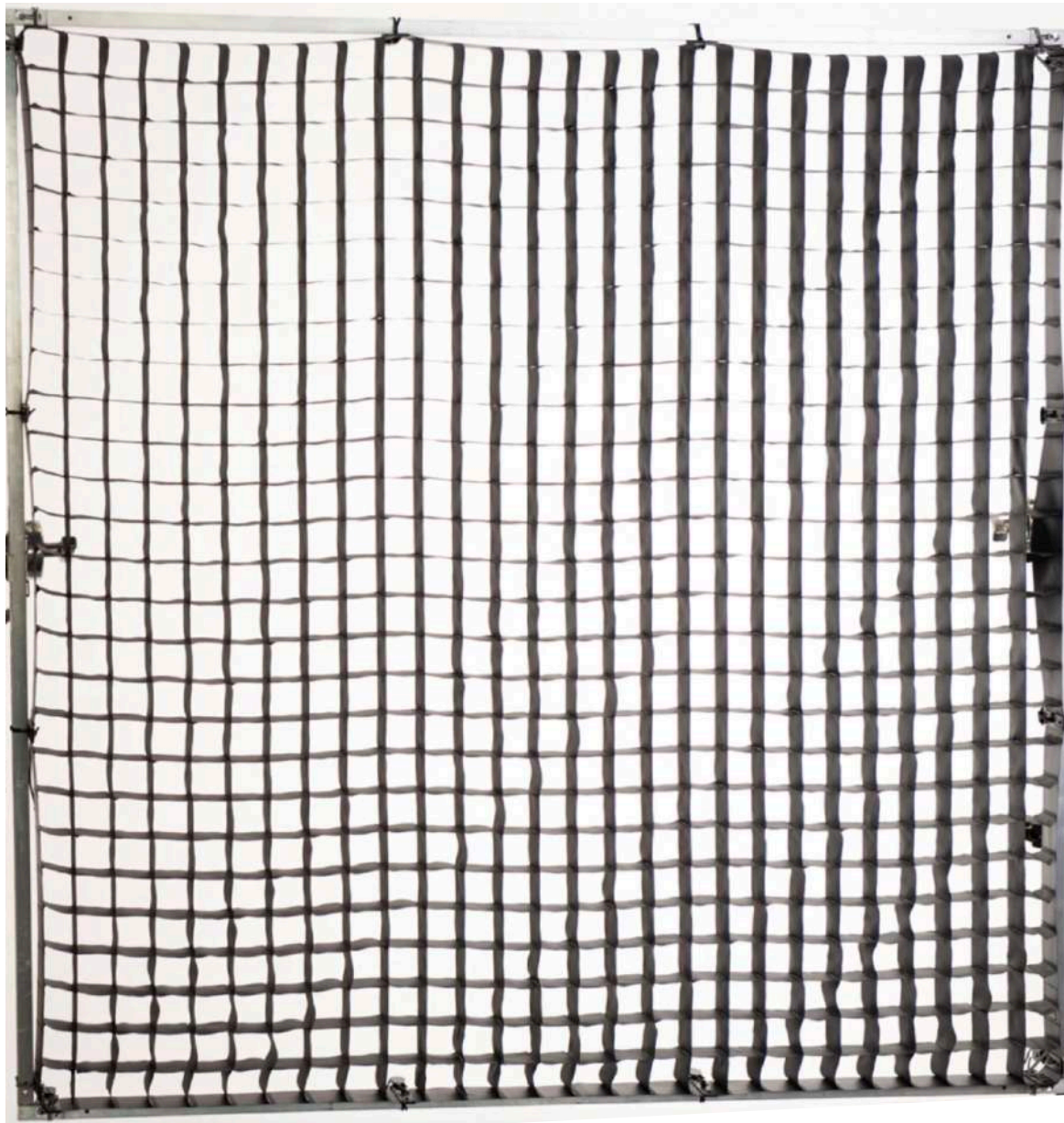

EGG CRATE

Light tools / Egg crate 2x2 40°

149 €

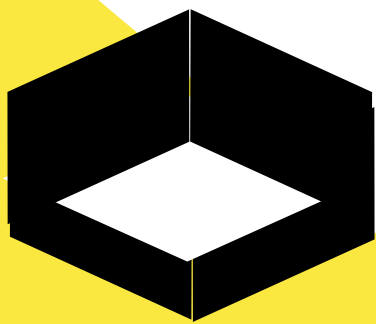

Gonna per farfalla 2x2

39 €

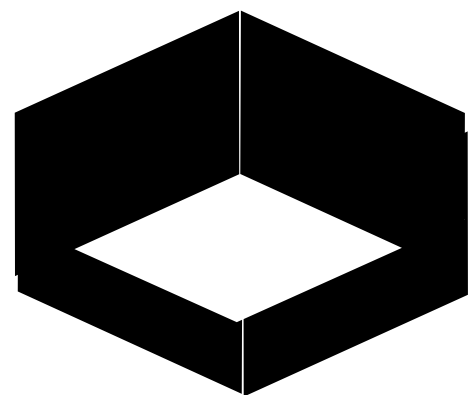

Gonna per farfalla 4x4

39 €



La grid 2x2 è fatta da un tessuto ricamato a mano, è molto delicata e va posizionata con cura. La sua funzione consiste nel restringere l'ampiezza del fascio di un banco di luce.

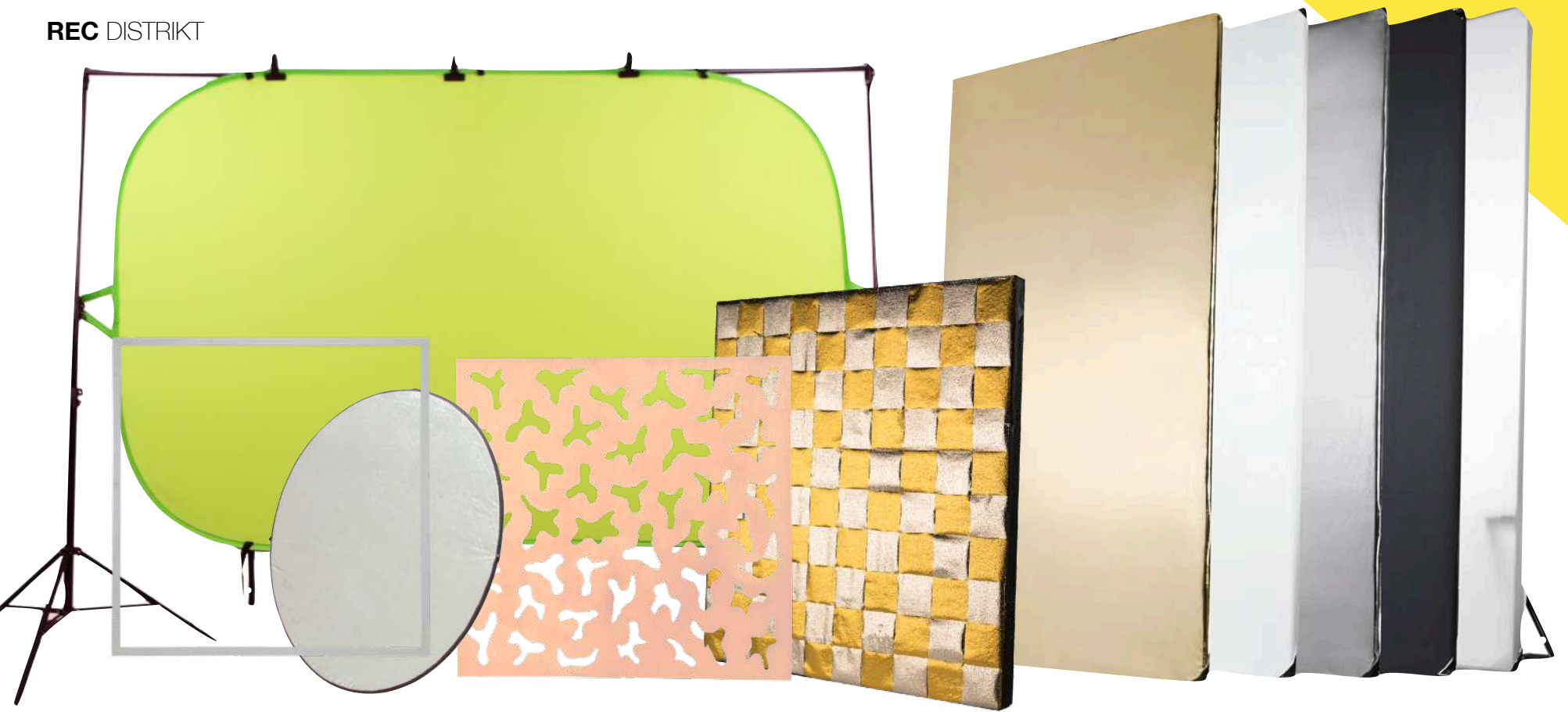

PANNELLI - FRAME



<i>Telaio in legno 1,2m x 1,2m</i>	5 €
<i>Telaio in legno 1m x 2m</i>	5 €
<i>Telaio in legno 1x2 con telo nero</i>	19 €
<i>Telaio Cucoloris</i>	19 €
<i>Poli 1x1 Black / White</i>	3 €
<i>Poli 1x1 Black / Silver</i>	6 €
<i>Poli 1x1 Silver / Gold</i>	15 €
<i>Poli 1x1 Scacchiera S / G</i>	19 €
<i>Poli 2x1 Black / White</i>	9 €
<i>Poli 2x1 Silver / White</i>	19 €
<i>Poli 3x1 Black / White</i>	29 €
<i>Walimex Pro Black / White / Silver / Gold / Diffusion</i>	29 €
<i>Lastolite green screen 180 x 275 cm</i>	29 €

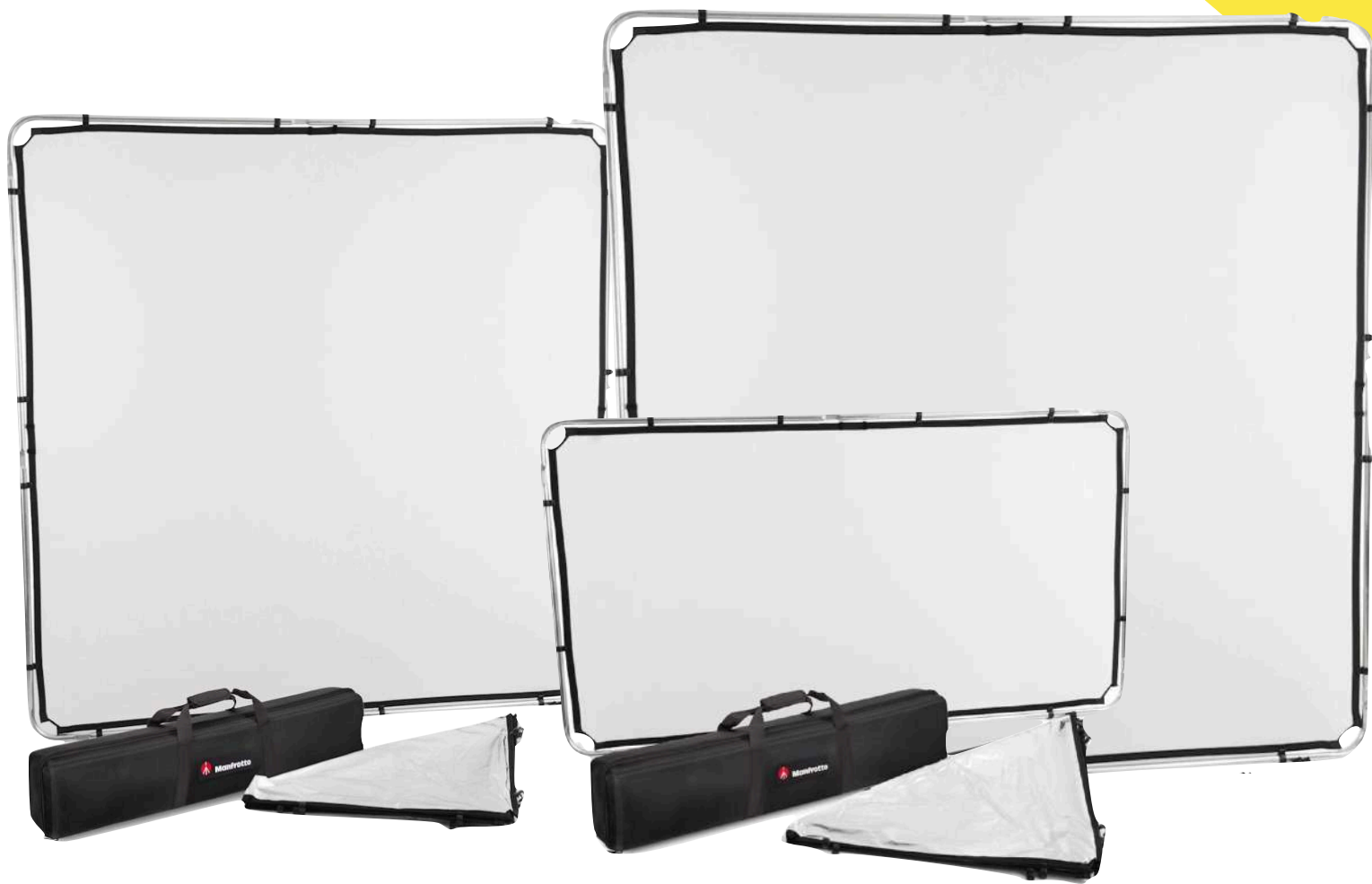

LASTOLITE SKYRAPID

	2X1	2X2	3X3
Telaio	9 €	19 €	39 €
Telo Skyrapid 0.75	9 €	15 €	19 €
Telo Skyrapid 1.25	9 €	15 €	19 €
Telo Skyrapid Argento - Bianco	9 €	15 €	--
Telo Skyrapid Nero - Bianco	9 €	15 €	--
Telo Skyrapid Sunfire - Bianco	9 €	15 €	--



Snodo per Skyrapid

5 €



SUNBOUNCE | SUNSWATTER

79 €

Telaio 130 x 190 cm

Telo traslucido 2/3

Boom stick

Boom support per cintura



BANDIERE E FLOPPY

Bandiera nera	<i>30 x 45 cm</i>	5 €
Bandiera nera	<i>40 x 60 cm</i>	5 €
Bandiera nera	<i>60 x 90 cm</i>	9 €
Bandiera nera	<i>46 x 120 cm</i>	19 €
Bandiera single scrim	<i>40 x 60 cm</i>	5 €
Bandiera double scrim	<i>40 x 60 cm</i>	5 €
Bandiera single scrim	<i>60 x 90 cm</i>	9 €
Bandiera double scrim	<i>60 x 90 cm</i>	9 €
Floppy flag nera	<i>120 x 120 cm</i>	29 €
Bandiera single scrim	<i>120 x 120 cm</i>	39 €
Bandiera double scrim	<i>120 x 120 cm</i>	39 €
Bandiera single scrim	<i>60 x 90 cm</i>	9 €
Bandiera double scrim	<i>40 x 60 cm</i>	5 €
Bandiera double scrim	<i>60 x 90 cm</i>	9 €
Kit x7 bandiere	<i>40 x 60 cm</i>	45 €

- *Single - Double scrim*
- *Single - Double white*
- *Silk art - 1/4*
- *Black*

Kit x7 bandiere	<i>60 x 90 cm</i>	59 €
------------------------	-------------------	-------------

- *Single - Double scrim*
- *Single - Double white*
- *Silk art - 1/4*
- *Black*

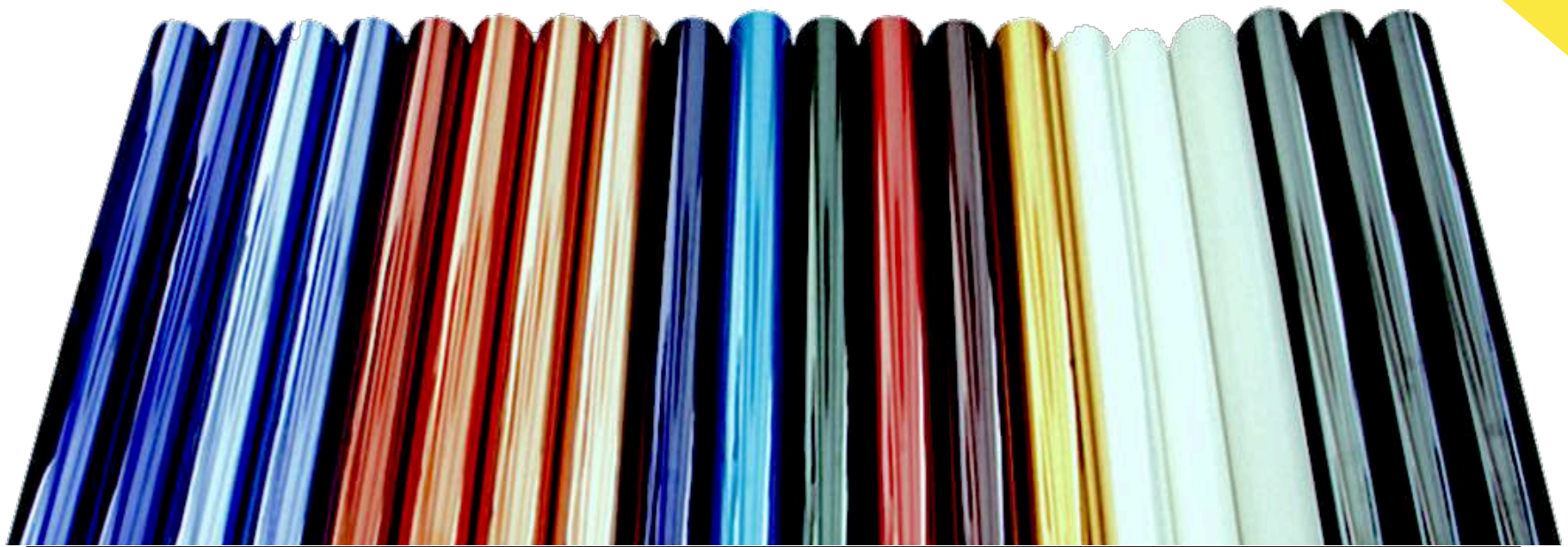

GELATINE

DIFFUSION	<i>Full - 1/2 - 1/4 - 1/8</i>	4 € / Feet
GRID CLOTH	<i>Full - 1/2 - 1/4 - 1/8</i>	9 € / Feet
CTO	<i>Full - 1/2 - 1/4 - 1/8</i>	4 € / Feet
CTB	<i>Full - 1/2 - 1/4 - 1/8</i>	4 € / Feet
CTS	<i>Full - 1/2 - 1/4 - 1/8</i>	4 € / Feet
PLUS GREEN	<i>Full - 1/2 - 1/4 - 1/8</i>	4 € / Feet
MINUS GREEN	<i>Full - 1/2 - 1/4 - 1/8</i>	4 € / Feet
ND	<i>0.3 - 0.6 - 0.9</i>	4 € / Feet
PRIMARY RED		4 € / Feet
DEEP AMBER		4 € / Feet
AMBER		4 € / Feet
MOONLIGHT BLUE		4 € / Feet
DEEP PURPLE		4 € / Feet
HAMPSHIRE FROST		9 € / Feet
SODIUM		4 € / Feet
CINEFOIL	<i>Rotolo</i>	49 €



"Nano"



"Baby"



"Puntale"



Wind up



CRANK & WIND UP

Super Wind up



Crank up



C-STAND



**RANKER
"Compasso MDP"**



OVERHEAD



CINE



"Low Boy"

ROLLER



**BABY
"Compasso"**



BABY ROLLER



AVENGER | WIND UP / SUPER WIND UP / CRANK UP

	WIND UP	SUPER WIND UP	CRANK UP
ALTEZZA MASSIMA	370 cm	366 cm	610 cm
ALTEZZA MINIMA	181 cm	156 cm	190 cm
PESO	25 Kg	32,5 Kg	76 Kg
MAX PAYLOAD	30 Kg	80 Kg	70 Kg
	29 €	39 €	79 €



Il termine *Wind Up* deriva dal verbo inglese "**To Wind**" avvolgere, non ha nulla a che fare con il "vento".

Crank Up invece deriva dal verbo inglese "**To crank**" girare / avviare a manovella.



AVENGER / KUPO | PUNTALI

	<i>H / max</i>	<i>H / min</i>	<i>Peso</i>	<i>Ruote</i>	<i>Payload</i>	
AVENGER <i>Puntale Combo 3 alzate</i>	4,5 m	1,7 m	7 kg	no	40 kg	9 €
KUPO <i>Puntale 3 alzate</i>	4,5 m	1,5 m	12 kg	no	40 kg	9 €
KUPO <i>Puntale 2 alzate</i>	3,5 m	1,4 m	11 kg	no	40 kg	8 €
MATTHEWS <i>Puntale 3 alzate</i>	4,5 m	1,5 m	9 kg	si	30 kg	15 €
KUPO <i>Puntale 3 alzate</i>	4,5 m	1,5 m	14 kg	si	30 kg	15 €
KUPO <i>Low boy</i>	1,2 m	1,5 m	7,1 kg	si	15 kg	9 €
KUPO <i>Puntale nano</i>	2,0 m	0,9 m	8 kg	no	35 kg	7 €
KUPO <i>Puntale Low Mighty</i>	1,1 m	0,64 m	4,2 kg	no	15 kg	6 €
AVENGER <i>Prolunga puntale corta</i>	0,5 m	0,5 m	0,5 kg			5 €
AVENGER <i>Prolunga puntale lunga</i>	1,0 m	1,0 m	1,0 kg			5 €
AVENGER <i>Prolunga puntale telescopica</i>	1,2 m	1,8 m	2,0kg			15 €

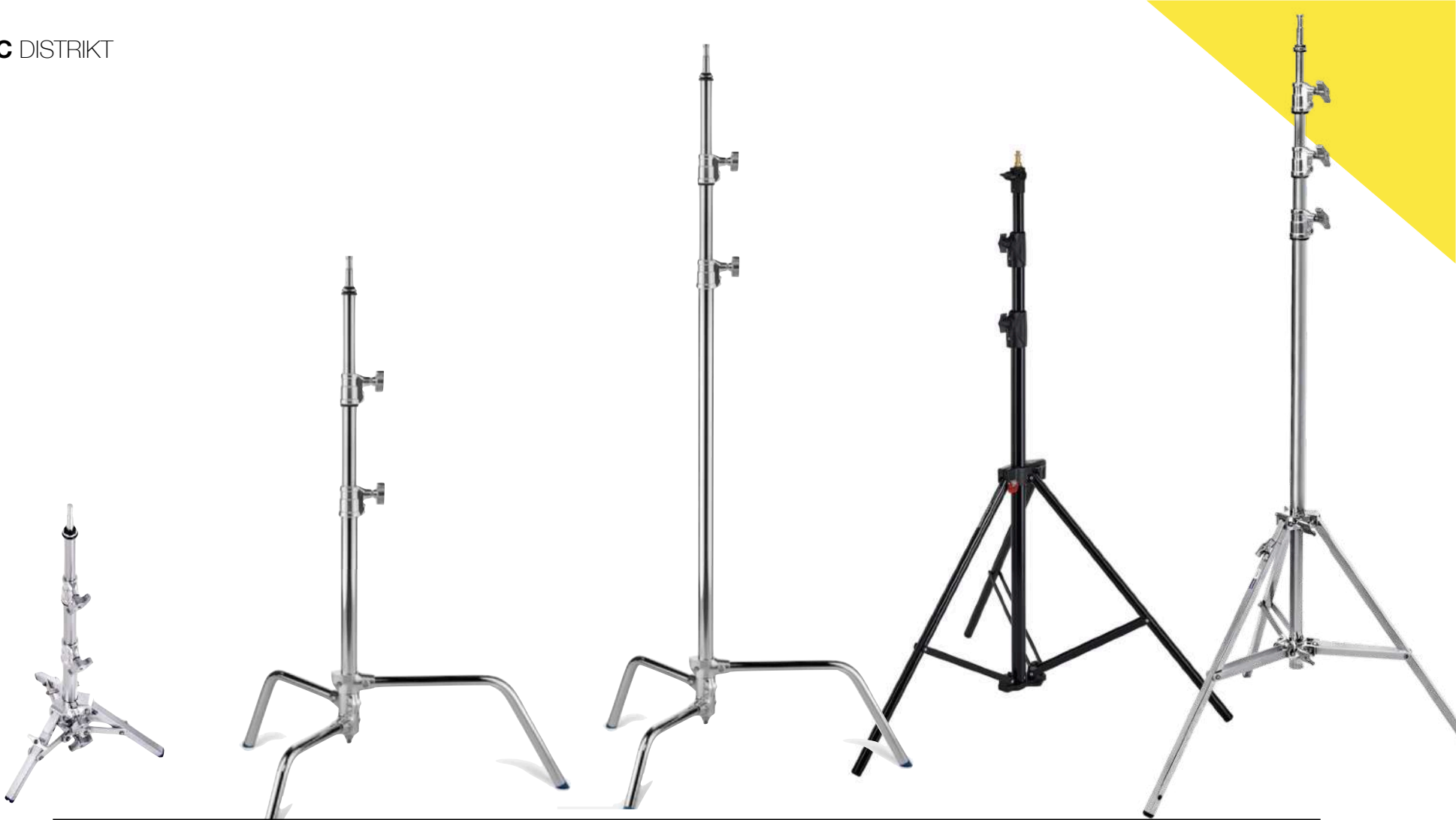

AVENGER / KUPO | C-STAND E BABY

	<i>H / max</i>	<i>H / min</i>	<i>Peso</i>	<i>Ruote</i>	<i>Payload</i>	
AVENGER <i>Baby Roller 3 alzate A0030</i>	3,1 m	1,2 m	6,8 kg	si	10 kg	9 €
AVENGER <i>Baby 3 alzate A0030</i>	3,0 m	1,1 m	6,5 kg	no	10 kg	7 €
AVENGER <i>C-Stand</i>	3,3 m	1,3 m	5 kg	no	10 kg	7 €
AVENGER <i>C-Stand baby</i>	1,7 m	0,8 m	4 kg	no	8 kg	7 €
AVENGER <i>Baby 2 alzate A0045CS</i>	4,5 m	1,5 m	8 kg	no	9 kg	7 €
KUPO <i>Stativo US-KS080311</i>	3,6 m	1,2 m	3 kg	no	9 kg	5 €
AVENGER <i>Baby nano 0010CS</i>	1,0 m	0,5 m	2,5 kg	no	15 kg	5 €



D200 Grip Head 2 1/2"
Cipolla
Ruzzola

3 €

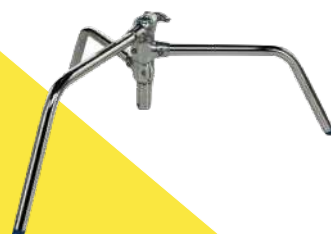

A2009 C-Stand Base
Piede da ponte
Gambe C-Stand

3 €



D500 20" Extension Grip Arm
Fustone Corto
Spadino

3 €



AVENGER | EXTENSION ARM

	<i>Max reach</i>	<i>Payload</i>	<i>Min reach</i>	<i>Payload</i>	<i>Peso</i>	
AVENGER <i>Mega Boom 425B</i>	3,6 m	6 kg	2,0 m	30 kg	15 kg	49 €
AVENGER <i>Junior Boom D650</i>	3,0 m	10 kg	1,6 m	40 kg	7 kg	19 €
AVENGER <i>Mini Boom D600</i>	2,1 m	7 kg	1,1 m	15 kg	3,7 kg	10 €



PESI E RIALZI

REC DISTRIKT Sand bag 8 kg	4 €
REC DISTRIKT Sand bag 15 kg	6 €
REC DISTRIKT Pedanine x10 "Kebab"	10 €
KUPO Apple Box	29 €
REC DISTRIKT Set di cubi	19 €



AMERICANE - TUBI - AUTOPOLE

<i>AMERICANA quadrata base 40 cm</i>	4 €
<i>AMERICANA quadrata base 30 cm</i>	6 €
<i>Tubo alluminio ø 5 cm 1m - 1,5m - 2m - 3m</i>	8 €
<i>Tubo alluminio giuntabile 2m</i>	5 €
<i>Autopole 100-170 cm</i>	5 €
<i>Autopole 200 - 370 cm</i>	9 €

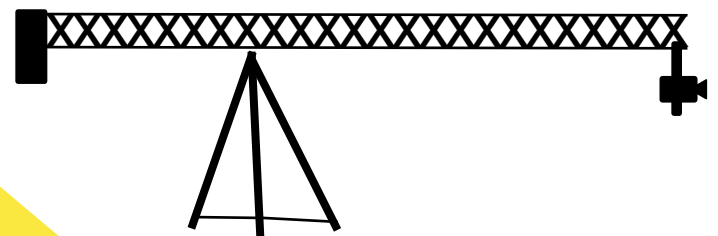

In caso si dovessero sollevare linee di americane con luci pesanti come gli ARRI SkyPanel, è consigliabile utilizzare **Super Wind Up** o **Crank Up**.

Con questo accessorio si può montare un'americana su un perno e assemblare un' "**americrane**". È indispensabile rivolgersi a un macchinista esperto.

FOG MACHINE



ARTEM

Macchina del fumo per esterni, ideale per capannoni e spazi aperti. Fumo sprigionato denso e getto intenso. L'effetto sarà più persistente in assenza di vento.

Attenzione: lasciar scaldare l'ugello per 3 minuti prima di aprire la valvola del fumo

199 €

bombola fumo e
bombola gas incluse

49 €

bombola fumo
extra

49 €

bombola gas
extra

INCENSO

Ideale per piccoli ambienti piccoli chiusi. Fumo delicato per un'atmosfera rarefatta fino a 200 metri cubi.



19 €

Diffusore

19 €

Incenso

5 €

Carbonella



LensGo

Ideale per piccoli ambienti piccoli chiusi. Fumo delicato per un'atmosfera rarefatta per ambienti fino a 200 metri cubi. Fumo consistente e permanente se usato con spugna di diffusione.

39 €

ADJ - Entour Chill

Machina del fumo basso, ma necessita di vero ghiaccio a cubetti. Getto fumo corposo e consistente. Per ambienti chiusi fino a 500 metri cubi.



49 €

ADJ - Entour Faze Jr

Machina del fumo ideale per realizzare un'atmosfera rarefatta in ambienti chiusi fino a 300 metri cubi.



49 €



GENERATORI E BATTERY BOX

HONDA EU 70 is	Alimentazione Benzina	Peso 124 Kg	Potenza max 7 Kw	Potenza nominale 5.5 Kw	220 V 32A	220 V 16A	220 V 16A	149 €	
HONDA EU 22 i	Benzina	20 Kg	2.2 Kw	1.8 Kw	220 V 16A	220 V 16A		49 €	
INSTAGRID	Alimentazione Corrente	Peso 20 Kg	Autonomia 2.1 Kw/h				220 V 15A	119 €	
ECOFLOW DELTA PRO	Corrente	45 kg	3,6 Kw/h		220 V 15A	220 V 15A	220 V 15A	220 V 15A	179 €



Con il generatore **Honda 70 is** è possibile alimentare un **ARRI M40** con bulbo da 4000w.

Con il generatore **Honda 22 i** è possibile alimentare un **ARRI M18** con bulbo da 1800w.



*Potenza
nominale*

*Potenza
massima*

In fase di **avviamento** impostare la potenza massima (Lepre), dopo circa 10 minuti reimpostare la modalità "tartaruga", sia per non far sforzare il motore che per consumare meno.

Il motore non è stato progettato per rimanere acceso a **velocità massima** per periodi troppo lunghi, potrebbe danneggiarsi o andare in protezione.

Quando si fanno **calcoli sulla portata** bisogna sempre usare come riferimento la **potenza nominale**, perché la potenza massima serve solo in fase di avviamento: come per le luci a scarica che hanno bisogno di più energia per innescare la reazione all'interno del bulbo.

CIVILE

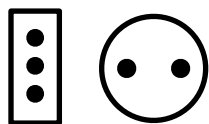

220 V
10A

INDUSTRIALE

MONO FASE

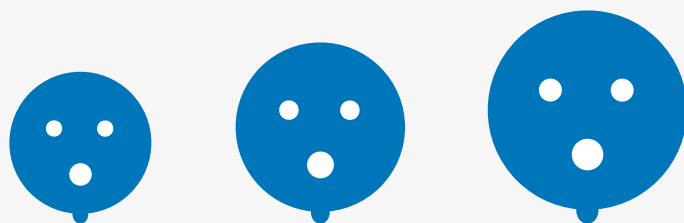

220 V
16A

220 V
32A

220 V
63A

TRI FASE



380 V
16A

380 V
32A

380 V
63A

Il sistema **Monofase** ha un solo filo di fase e, se si verifica un guasto sulla rete, l'alimentazione si interrompe completamente. Ma nel sistema **Trifase** la rete ha tre fasi e se il guasto si verifica su una qualsiasi delle fasi, le altre due forniranno continuamente l'alimentazione.

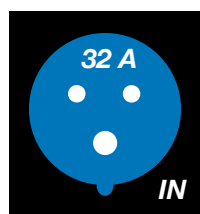
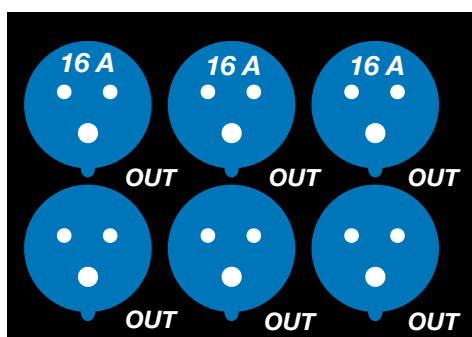

Con questa ciabatta industriale, in gergo chiamata "centobuchi", si trasforma una linea 32 Mono in 6 linee 16 Mono

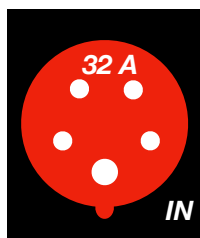
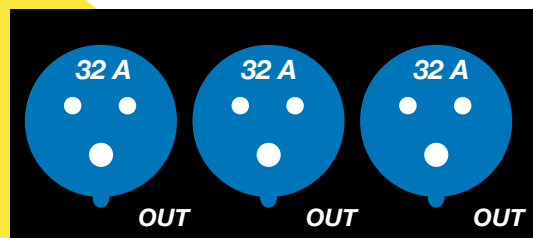

Con questa ciabatta industriale, si trasforma una linea 32 Penta in 3 linee 32 Mono

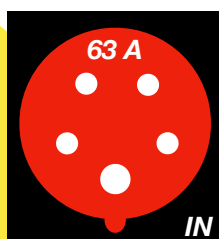
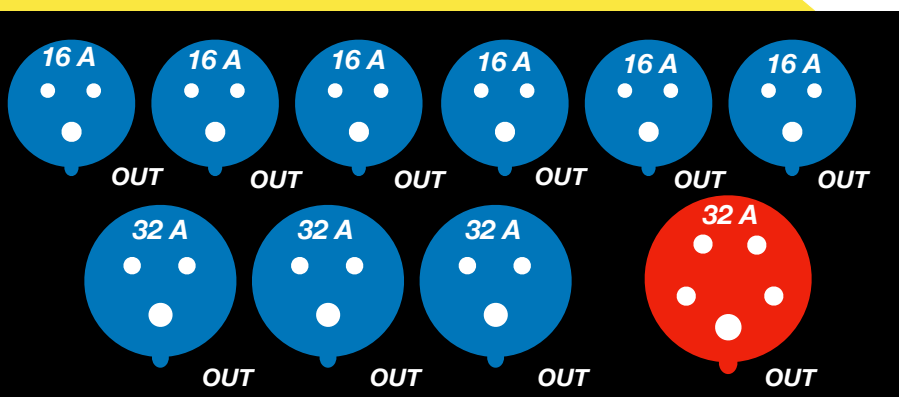

Con questo box di distribuzione si trasforma una 63 Penta, in una linea 32 Penta, 3 linee 32 Mono e 6 linee 16 Mono

PROLUNGHE

<i>Civile</i>	15 A		10 m	3 €
<i>Civile</i>	15 A		20 m	4 €
<i>Civile Ruzzola</i>	15 A		25 m	5 €
<i>Civile Ruzzola</i>	15 A		50 m	7 €
<i>Industriale</i>	16 A	<i>Monofase</i>	10 m	6 €
<i>Industriale</i>	16 A	<i>Monofase</i>	20 m	7 €
<i>Industriale</i>	32 A	<i>Monofase</i>	10 m	7 €
<i>Industriale</i>	32 A	<i>Monofase</i>	20 m	8 €
<i>Industriale</i>	32 A	<i>Trifase</i>	10 m	8 €
<i>Industriale</i>	32 A	<i>Trifase</i>	20 m	10 €
<i>Industriale</i>	63 A	<i>Trifase</i>	10 m	15 €

CIABATTE

<i>Civile</i>				2 €
<i>Industriale</i>	15 A	x1 32 mono x2 16 mono		10 €
<i>Industriale</i>	16 A	x1 32 trifase x3 32 mono		15 €
<i>Industriale</i>	32 A	x1 32 trifase x3 32 mono		19 €

ADATTATORI



Scame
Dona-Corrente
Barilotto

1 €



Scame inverso (Emacs)
Ruba-Corrente

1 €



Shuko

0,5 €



Shuko inversa

0,5 €